

AMERICH®

MADISON® 6036

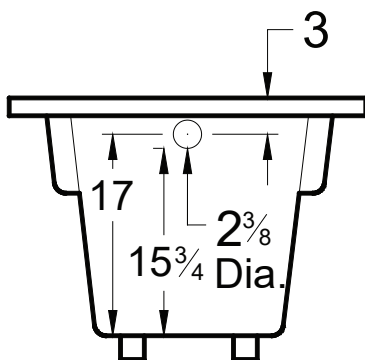
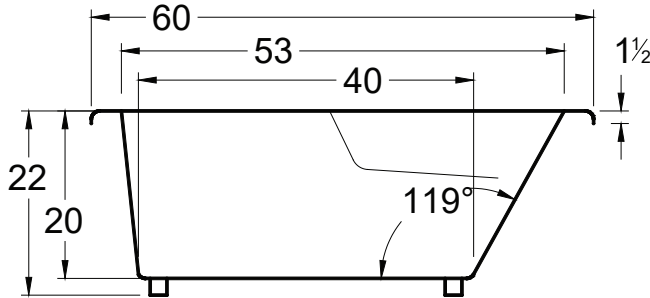
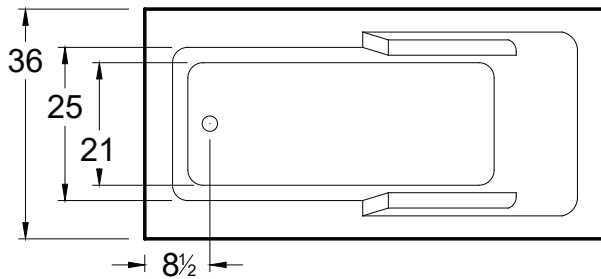

DIMENSIONS

60" x 36" x 22" (1524 x 915 x 559 mm)

Whirlpool Operating Gallons = 40 (Liters = 151)

Gallon to Overflow = 65 (Liters = 246)

MATERIAL

Acrylic

TUB FLOOR

Textured

UNDERMOUNT: YES

- Americh tub decks are designed with a slight pitch toward the bathing well so water will drain into the tub. You must advise Americh if the tub will be undermounted and we will flatten the deck to ease installation.
- If tub has deck mounted controls, advise Americh of undermount and we will ship controls loose for field installation.
- When cutting undermount surface (ie, marble, granite, etc) always take dimensions directly from the unit.

APPROVALS & COMPLIANCE



Americh products meet or exceed the following standards:

- Underwriters Laboratories (UL)
- Underwriters Laboratories - Canada (cUL)
- ANSI Z124.1 • ANSI A112-19.7
- ANSI A112.19.8

Contact Americh for additional approvals.

STANDARD EQUIPMENT

- Adjustable leveling legs

BATHING SYSTEMS

LEGEND

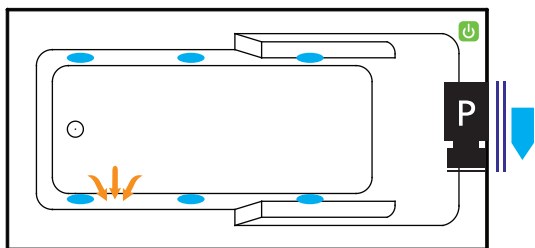

Builder Series

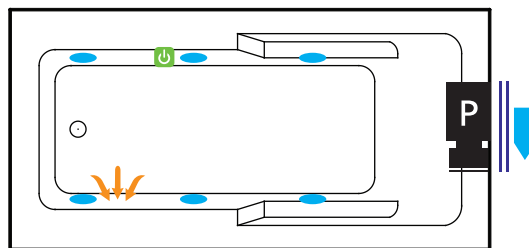

Luxury Series

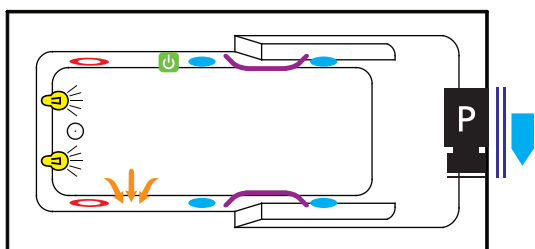

Platinum Series

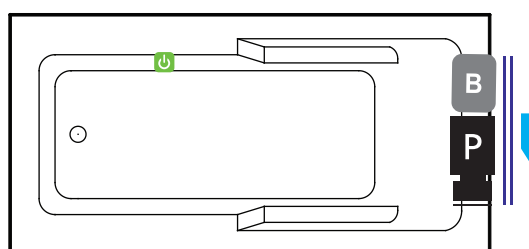

Combination
(pump and blower location only)

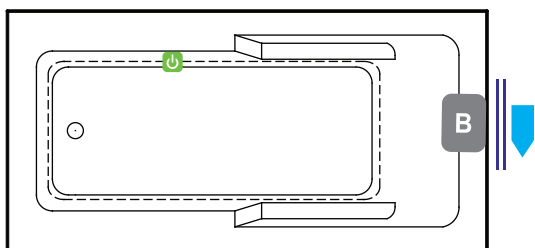

Airbath System II

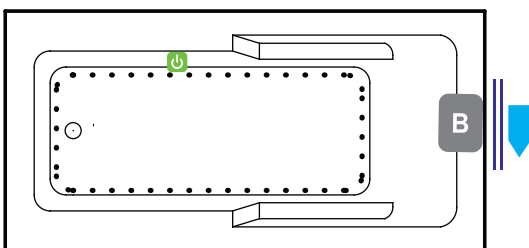

Airbath System V



Pump



Blower



Jet



Rotary Jet



Suction



Light



ON/OFF Control



Grab Bar



Access Panel
(Minimum 16" X 20")



MFG IDLabel

OPTIONAL ACCESSORIES

- ANEX (Americh Nanobubble Experience)
- Apron
 - Flat Panel
 - Removable Panel
 - Urban Storage Tray Available
- Chromatherapy*
- Grab Bars: 9" * - 14" - 16"
- High Density Insulation*
- iBath Sound System
- Inline Heater (whirlpool only)
- Jets: Additional or Rotary*
- Lo Profile Tub Edge
- Ozone System (whirlpool and/or Airbath only)
- Pillows: 12" * - Angle
- Remote Control Upgrade (select series only)
- Serenity Soak (tub only)
- Syllent Pump with Heated Air*
- Thermal Comfort System
(TCS must be at opposite end if used with VSM)
- Tile Flange Kit
- Trim Kit Upgrade*
- Vibro Sonic Massage
(VSM must be at opposite end if used with TCS)
- Waste & Overflows Upgrades
 - Cable Drive Waste & Overflow*
 - PVC Waste & Overflow
 - Linear Waste & Overflow

(* Standard on Platinum Series

(+ Standard on Luxury Series

INSTALLATION TIPS

1. Install according to Owner's Manual and local codes.
2. Always consult your local plumber for recommendations as installations will vary.
3. Any tub with whirlpool, Airbath or ANEX system requires an access panel (16"x20" minimum)
4. Template for undermounting tubs are available upon request. It is always recommended to wait for unit to arrive for accuracy.
5. The combination of multiple systems and options may require components to stick out and/or be remotely installed in the field.
6. Center Drain tubs with Linear Drain option may not use 9" Grab Bar option. Only 14" or 16" Grab Bar option is available with these units.
7. Hot water supply should be 65%-75% of tub capacity or greater.

ELECTRICAL REQUIREMENTS

Americh recommends one 20 amp ground fault circuit interrupter (GFCI) for each power supply provided with the bathtub.